

Distribution block / Phasenverteilungblocke / Bloque de distribución

DB-6



TECHNICAL DATA / TECHNISCHE DATEN / DATOS TÉCNICOS





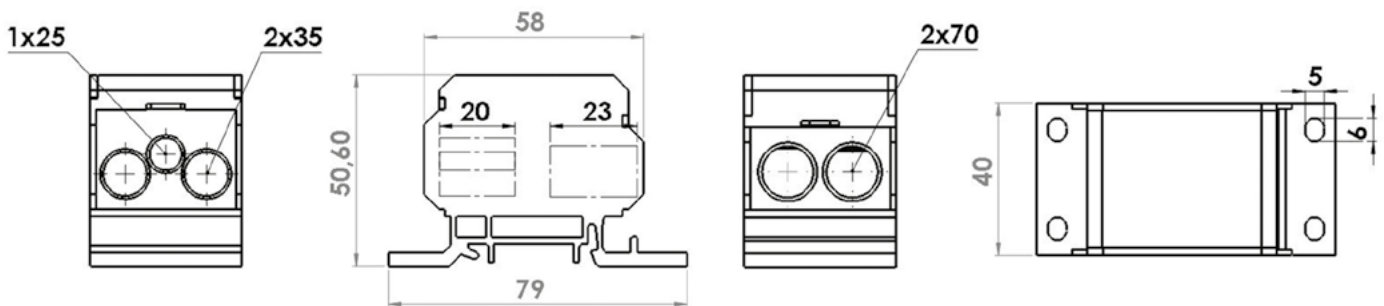

I_n	Max. current / max. Schienestrom / Capacidad de carga actual	192 [A]
U_i	Rated insulation voltage / Bemessungsisolationsspannung / Tensión nominal de aislamiento	1000 AC / 1500 DC [V]
U_{imp}	Surge voltage / Bemessungsschossspannung / Tensión nominal de choque tolerada	12 [kV]
	Material of insulation / Werkstoff für Isolierung / Material de aislamiento	PA6.6
	Material of insert / elektrisches Leitermaterial / Material de inserto	BRASS / MESSING / LATÓN

TYPE TYP TIPO	CROSS-SECTION QUERSCHNITT SECCIÓN [mm ²]	AVAILABLE COLORS VERFUGBARE FARBEN COLORES DISPONIBLES	CATALOGUE NUMBER KATALOGNUMMER NÚMERO DE CATÁLOGO	PACKAGING / VERPACKUNG / EMBALAJE	
				Single package / Packungseinheit / Embalaje individual [pcs]/[kg]	Collective packaging / Sammelverpackung / Embalaje colectivo [pcs]/[kg]
DB-6/SZ	70	GREY / GRAU / GRIS	0670235225101	5/1,06	100/21,2
DB-6/N	70	BLUE / BLAU / AZUL	0670235225102	5/1,06	100/21,2
DB-6/ZZ	70	GREEN-YELLOW / GRÜN GELB / VERDE AMARILLO	0670235225103	5/1,06	100/21,2



CHARACTERISTICS OF BLOCK / EIGENSCHAFTEN VON BLOCKTERMINALS / CARACTERÍSTICAS DE ENCHUFES Y BORNES DEL BLOQUE

EXIT / ABGANG / SALIDA

Cross-sectional area Querschnittsfläche Área de sección [mm ²]	Wire type Drahtart Tipo de cable	Cross section of wires Querschnitt der Drähte Sección de los cables [mm ²]	Screw type Art. der Schrauben Tipo de tornillos ⊙	Max. connections Max. Anschlüsse Número de enchufes	Socket depth Sockeltiefe Profundidad de enchufe [mm]	Hexagon socket, screw keys Innensechskant, Schraubenschlüssel Tamaño de llave allen	Max. torque Max. Drehmoment Par de apriete máx. [Nm]	Fixing method Befestigungsmethode Método de fijación	
								TH 35	Ø] 4 mm
25		2,5-25	M8x8	1	19,7	3	3	+	+
		2,5-16	M8x8						
35		2,5-35	M10x14	2	20	5	10	+	+
		4-25	M10x14						
70		4-70	M12x14	2	23,2	6	14	+	+
		6-50	M12x14						

ACCESS / ZUGANG / CONEXIÓN

Quality Control:



TÜV
Verified product
No: 0000082365
www.certhkat.tuv-nord.pl



IEC 60947-7-7:1-2009